

BATERTECH 03 KMA II PC

BAT 03 KMA II PC



- Źródło światła: świetlówka T5, T8
- Materiał obudowy: jn.
- Materiał klosza: jn.
- Zasilanie: 230 V AC
- Sposób montażu: nabudowywana, zwieszana
- Układ zapłonowy: elektroniczny lub magnetyczny
- Klasa ochrony przed prądem elektrycznym: I
- Zastosowanie: wewnątrz lub na zewnątrz budynku
- Wykonanie: ST, AT
- Czas pracy awaryjnej: 1,2,3h
- Czas ładowania baterii: maksymalnie 24h
- Typ baterii: NiCd
- Tryb pracy: M, NM

BATERTECH 03 KMA II PC

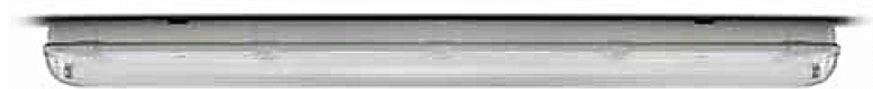

Podstawa: ABS; zapinki i klosz: PC

Statecznik EVG



szary / grey
szary / grey
szary / grey
szary / grey
szary / grey
szary / grey



[W]

1 x 18
1 x 36
1 x 58
2 x 18
2 x 36
2 x 58



[g]

880
1460
1830
1090
1880
2370

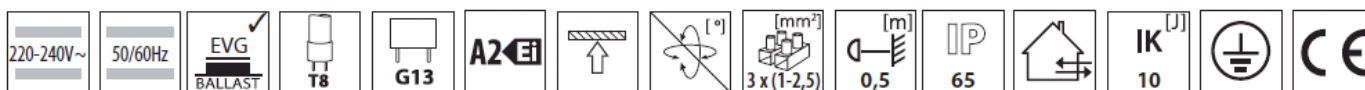

krzywa rozsyłu światłości /
curve of intensity distribution
 $\eta = 77\%$

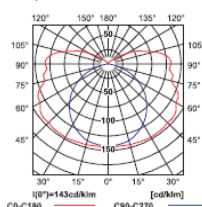

C0-C180 $\beta(0^\circ)=143\text{cd/klm}$ C90-C270
118-ABS/PC

krzywa rozsyłu światłości /
curve of intensity distribution
 $\eta = 77\%$

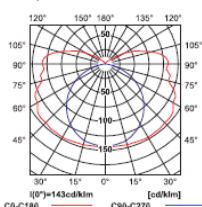

C0-C180 $\beta(0^\circ)=143\text{cd/klm}$ C90-C270
136-ABS/PC

krzywa rozsyłu światłości /
curve of intensity distribution
 $\eta = 77\%$

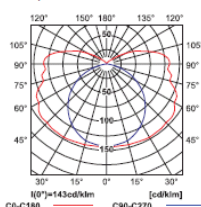

C0-C180 $\beta(0^\circ)=143\text{cd/klm}$ C90-C270
158-ABS/PC

krzywa rozsyłu światłości /
curve of intensity distribution
 $\eta = 65\%$

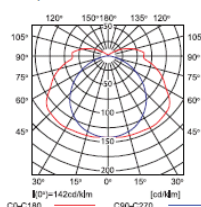

C0-C180 $\beta(0^\circ)=142\text{cd/klm}$ C90-C270
218-ABS/PC

krzywa rozsyłu światłości /
curve of intensity distribution
 $\eta = 65\%$

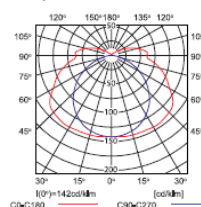

C0-C180 $\beta(0^\circ)=142\text{cd/klm}$ C90-C270
236-ABS/PC

krzywa rozsyłu światłości /
curve of intensity distribution
 $\eta = 65\%$

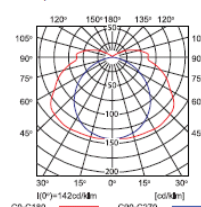

C0-C180 $\beta(0^\circ)=142\text{cd/klm}$ C90-C270
258-ABS/PC

BATERTECH 03 KMA II PC

118-ABS/PC - 90
136-ABS/PC - 90
158-ABS/PC - 90

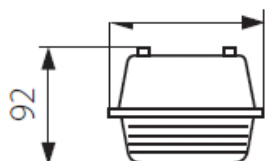

118-ABS/PC - 660
136-ABS/PC - 1265
158-ABS/PC - 1570

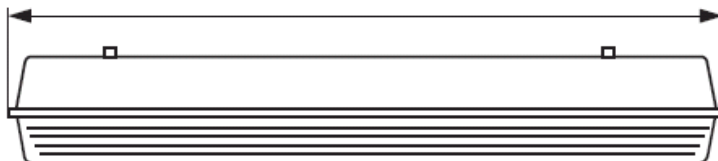

218-ABS/PC - 125
236-ABS/PC - 125
258-ABS/PC - 125

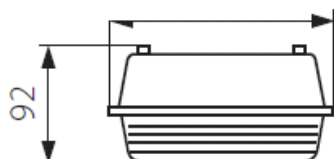

218-ABS/PC - 660
236-ABS/PC - 1265
258-ABS/PC - 1570

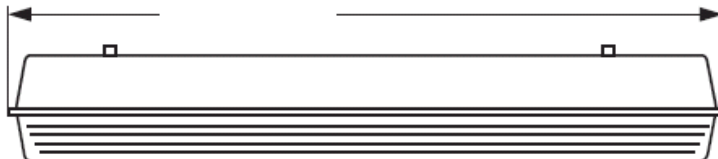

Podstawa: ABS; zapinki: PC; klosz: PS

Statecznik EVG



szary / grey
szary / grey
szary / grey
szary / grey
szary / grey
szary / grey



[W]

1 x 18
1 x 36
1 x 58
2 x 18
2 x 36
2 x 58



[g]

870
1420
1730
1070
1840
2310

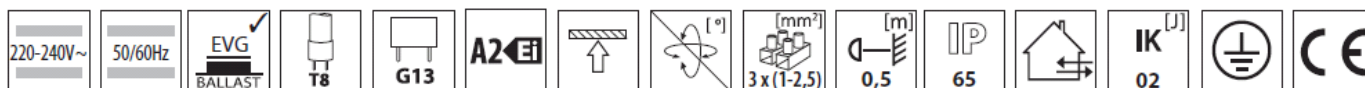

BATERTECH 03 KMA II PC

krzywa rozsyłu światłości /
curve of intensity distribution
 $\eta = 77\%$

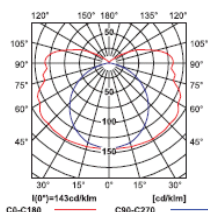

118-ABS/PS

krzywa rozsyłu światłości /
curve of intensity distribution
 $\eta = 77\%$

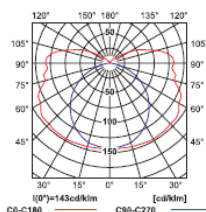

136-ABS/PS

krzywa rozsyłu światłości /
curve of intensity distribution
 $\eta = 77\%$

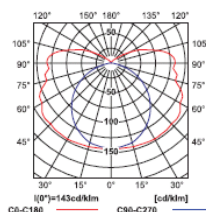

158-ABS/PS

krzywa rozsyłu światłości /
curve of intensity distribution
 $\eta = 65\%$

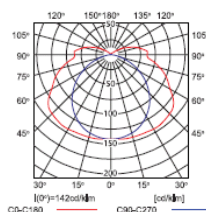

218-ABS/PS

krzywa rozsyłu światłości /
curve of intensity distribution
 $\eta = 65\%$

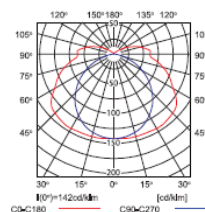

236-ABS/PS

krzywa rozsyłu światłości /
curve of intensity distribution
 $\eta = 65\%$

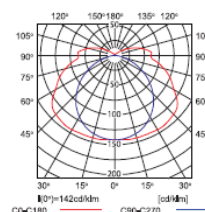

258-ABS/PS

118-ABS/PS - 90
136-ABS/PS - 90
158-ABS/PS - 90

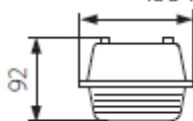

118-ABS/PS - 660
136-ABS/PS - 1265
158-ABS/PS - 1570

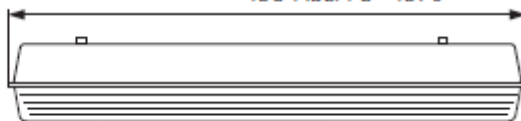

218-ABS/PS - 125
236-ABS/PS - 125
258-ABS/PS - 125

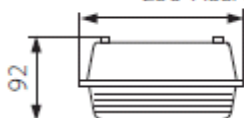

218-ABS/PS - 660
236-ABS/PS - 1265
258-ABS/PS - 1570

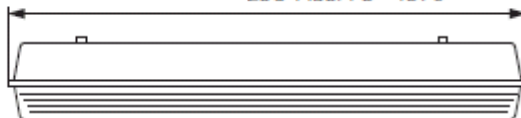

Podstawa: ABS; zapinki i klosz: PC

Statecznik VVG

szary / grey	18	VVG ✓	B2	1490
szary / grey	36	VVG ✓	B2	2200
szary / grey	58	VVG ✓	B2	2900
szary / grey	2 x 18	VVG ✓	B2	1920
szary / grey	2 x 36	VVG ✓	B2	3430
szary / grey	2 x 58	VVG ✓	B2	4810

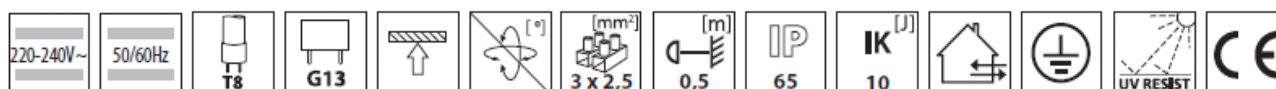

BATERTECH Filip Raróg ul. Sarmacka 28b/13, 02-972 Warszawa

Dział Handlowy/Produkcja: ul. Mazowiecka 142, 05-825 Książenice, tel. 22 734-33-02, fax 22 734-33-02,

www.batertech.com.pl; batertech@batertech.com.pl; NIP 526-219-07-54

BATERTECH 03 KMA II PC

krzywa rozsyłu światłości /
curve of intensity distribution
 $\eta = 72\%$

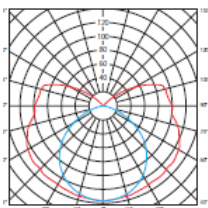

118

krzywa rozsyłu światłości /
curve of intensity distribution
 $\eta = 86\%$

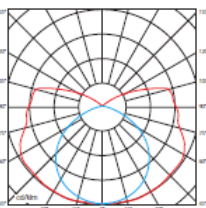

136/A

krzywa rozsyłu światłości /
curve of intensity distribution
 $\eta = 80\%$

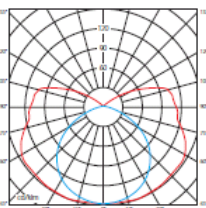

158

krzywa rozsyłu światłości /
curve of intensity distribution
 $\eta = 70\%$

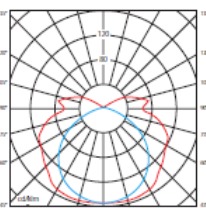

218

krzywa rozsyłu światłości /
curve of intensity distribution
 $\eta = 74\%$

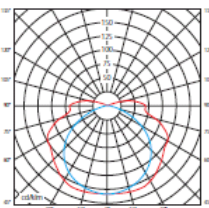

236/

krzywa rozsyłu światłości /
curve of intensity distribution
 $\eta = 73\%$

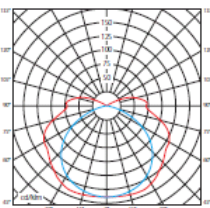

258

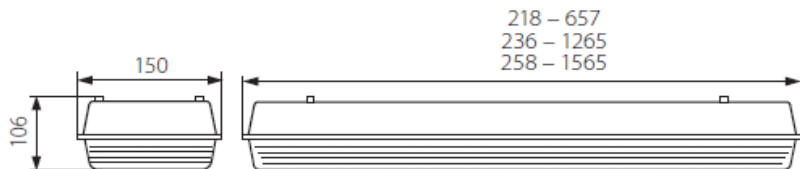
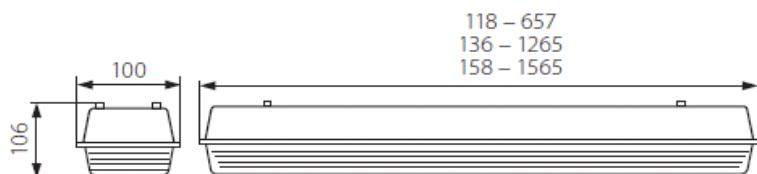

Podstawa i zapinki: poliester wzmocniony włóknem szklanym; klosz: PC



szary / grey
szary / grey
szary / grey
szary / grey
szary / grey
szary / grey
szary / grey
szary / grey
szary / grey
szary / grey
szary / grey
szary / grey
szary / grey
szary / grey
szary / grey



[W]

1 x 14
1 x 24
1 x 28
1 x 54
1 x 35
1 x 49
1 x 80
2 x 14
2 x 24
2 x 28
2 x 54
2 x 35
2 x 49
2 x 80



[g]



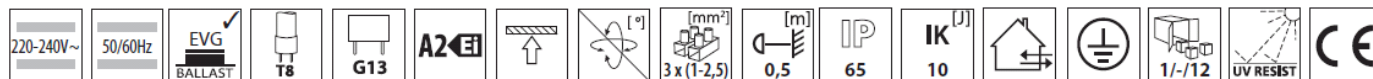

1700
1700
2200
2200
2600
2600
2600
2300
2300
2500
2500
2800
2800
2800

BATERTECH 03 KMA II PC



Podstawa: ABS; zapinki: PC; klosz: PS

Statecznik VVG

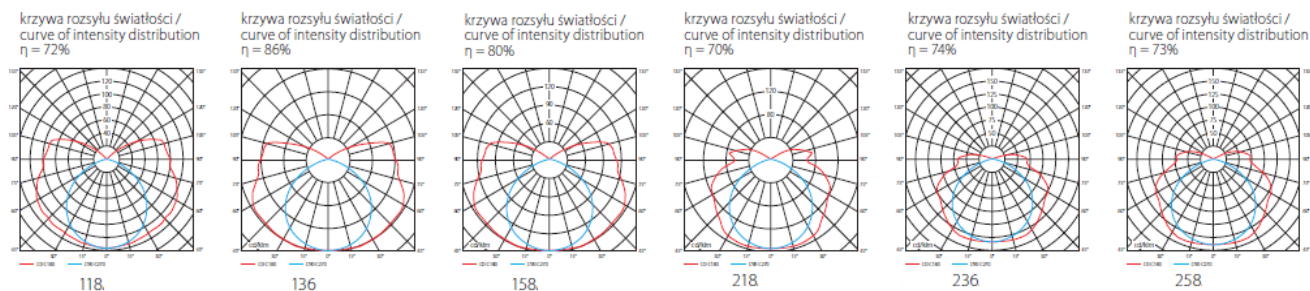

				
szary / grey	18	VVG ✓	B2	1450
szary / grey	36	VVG ✓	B2	2150
szary / grey	58	VVG ✓	B2	2810
szary / grey	2 x 18	VVG ✓	B2	1810
szary / grey	2 x 36	VVG ✓	B2	3410
szary / grey	2 x 58	VVG ✓	B2	4700

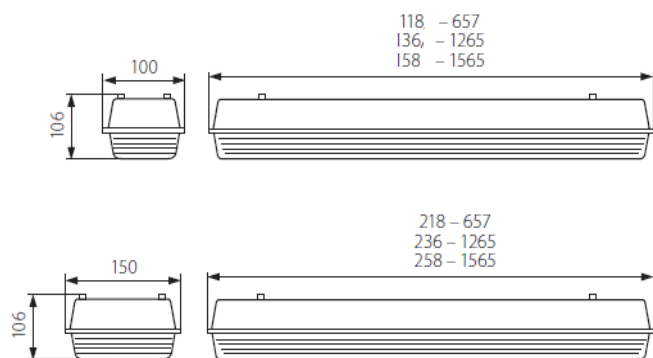

BATERTECH 03 KMA II PC



Podstawa i zapinki: poliester wzmocniany włóknem szklanym; klosz: PC
Statecznik EVG;

	 [W]	 [g]
szary / grey	1 x 18	2000
szary / grey	1 x 36	2500
szary / grey	1 x 58	3200
szary / grey	2 x 18	2300
szary / grey	2 x 36	3400
szary / grey	2 x 58	4600

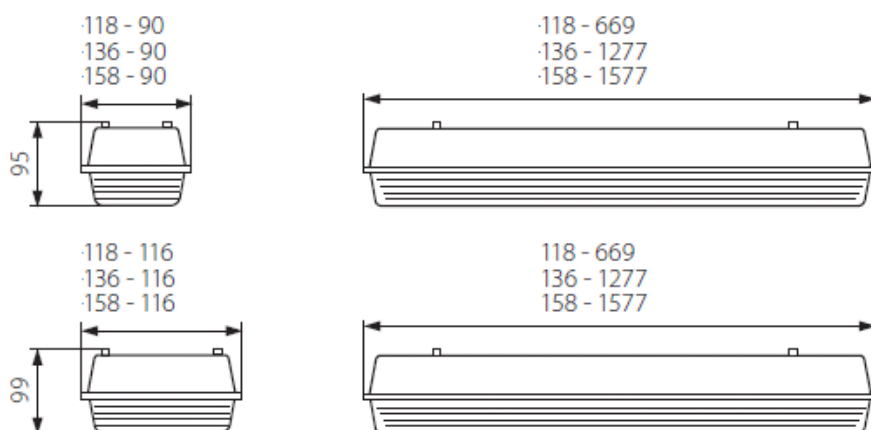

BATERTECH 03 KMA II PC

	[W]	[g]
szary / grey	1 x 14	1700
szary / grey	1 x 24	1700
szary / grey	1 x 28	2200
szary / grey	1 x 54	2200
szary / grey	1 x 35	2600
szary / grey	1 x 49	2600
szary / grey	1 x 80	2600
szary / grey	2 x 14	2300
szary / grey	2 x 24	2300
szary / grey	2 x 28	2500
szary / grey	2 x 54	2500
szary / grey	2 x 35	2800
szary / grey	2 x 49	2800
szary / grey	2 x 80	2800

