

### Model No.: GP160AFHT

<b>Type</b>	: High Temperature Rechargeable Nickel Metal Hydride Cylindrical Cell
<b>Nominal Dimension (with Sleeve)</b>	: $\Phi = 17.0\text{mm}$ H = 43.0mm
<b>Applications</b>	: Long term standby use. Recommended discharge current: 160mA to 800mA
<b>Nominal Voltage</b>	: 1.2V
<b>Capacity</b>	: Nominal: 1600mAh Minimum: 1600mAh Typical: 1680mAh When discharged at 320mA to 1.0V at 20°C
<b>Charging Condition</b>	: Standard mode: 160mA for 16 hrs at 20°C Standby intermittent mode: 160mA for 16 hrs at 20°C then maintenance with 160mA for 1min/10mins.
<b>Service Life</b>	: >500 cycles (IEC 61951-2)
<b>Continuous Overcharge</b>	: Comply with IEC 61951-2 Permanent Charge Endurance Test
<b>Weight</b>	: 33.0g
<b>Internal Resistance</b>	: Average 20 m $\Omega$ upon fully charged (Range 16-24 m $\Omega$ ) at 1000Hz
<b>Max. Charging Voltage</b>	: 1.6V at 160mA charging
<b>Ambient Temperature Range</b>	: Charge: 0 to 50°C Discharging: -20 to 70°C Storage: -20 to 35°C Storage (1 week): -20 to 60°C

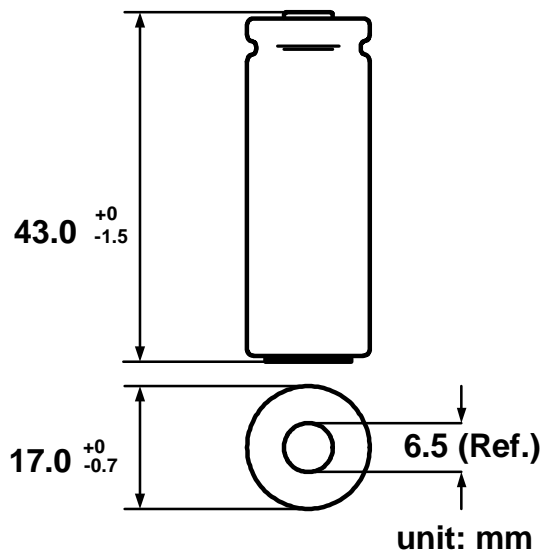

#### Low Rate Discharge

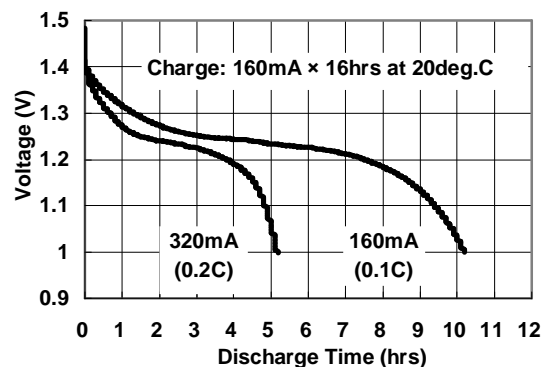

#### Charge & Discharge efficiency Vs. temp.

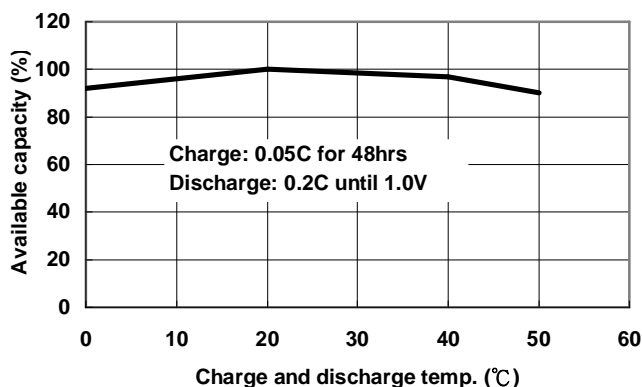

#### High Rate Discharge

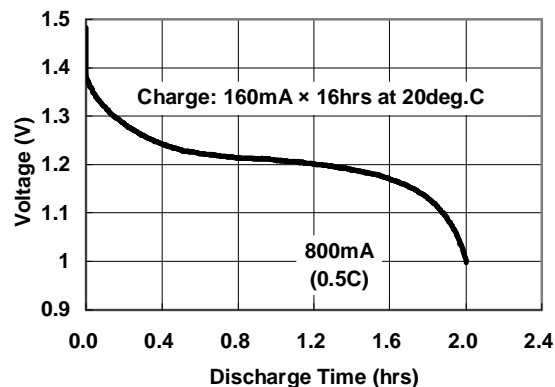

The information (subject to change without prior notice) contained in this document is for reference only and should not be used as a basis for product guarantee or warranty. For applications other than those described here, please consult your nearest GP Sales and Marketing Office or Distributors.